

MECHATRONIC SYSTEMS CONTROL BASED ON SCADA SYSTEM, OPC SERVER AND LABVIEW*

UDC 681.5:007.52 004.732.5.057.4 004.4SCADA

**Slobodan Aleksandrov¹, Zoran Jovanović²,
Saša Nikolić², Stanimir Čajetinac³**

¹Engineering School Trstenik, Vuka Karadžića 11, 37240 Trstenik, Serbia

E-mail: aleksandrovs@yahoo.com

²University of Nis, Faculty of Electronic Engineering, Department of Control Systems,
Aleksandra Medvedeva 14, 18000 Niš, Serbia

E-Mail: zoran.jovanovic@elfak.ni.ac.rs, sasa.s.nikolic@elfak.ni.ac.rs

³College of Applied Mechanical Engineering, Radoja Krstica 19, 37240 Trstenik, Serbia

E-mail: caja.dublje@gmail.com

Abstract. *The paper deals with SCADA system for controlling and monitoring mechatronic systems which are controlled by programmable logical controllers (PLC) and connected into local area network (LAN). Application OPC Easy Server is used to access PLC, software package LabView is used to create graphical control environment, and Festo software FST 4.10 is used to program PLC. Each PLC has its own unique IP address whereas each input and output PLC signal has its own local address. The realized system enables graphical interface for control and monitoring of physical values of the system processes and parameters. A big advantage of the solution presented in this paper is the possibility to control systems which are realized with different types of PLCs and with PLCs made by different producers, possibility to control systems in the local area network as well as control and monitoring of mechatronic systems by Internet regardless of geographic position of the operator and process.*

Key words: *control, mechatronic system, PLC, OPC server, TCP/IP, Internet*

1. INTRODUCTION

Rapid development of computer and information technologies provides realization of distributed computer control in real time from any geographical position. The systems of automatic control use PLCs (Programmable Logic Controllers) made by different manu-

Received November 02, 2011

* **Acknowledgement:** The work presented here was supported by the Serbian Ministry of Education and Science (project TR35005).

facturers and which are not mutually compatible. Application of different industrial communication networks, different network standards and incompatibility are the problems which should be overcome by new technologies. The need for exchanging data between PLCs made by different manufacturers and Windows environment in a standardized manner by unique interface has resulted in the development of OPC application (OLE for Process Control). OPC functions according to Client/Server principle in which client and server can be combined regardless of PLC type and manufacturer. The client can have access through any communication network or from any remote position and there is no need to take account of the way physical data are organized. Owing to fast Internet, it is possible nowadays to access, control and monitor distributed systems of automatic control in real time. LabVIEW environment, made by National Instruments, is used to create graphical interface (Graphical User Interface – GUI) which enables monitoring the data acquisition and system control. Connecting the LabVIEW application, OPC and PLC results in the following:

- Monitoring and predictive maintenance
- High-speed measurements from a broad range of sensors
- Data logging
- Statistical process control
- Sharing data between PLCs, other automation devices and PC applications
- Developing Graphical User Interfaces
- Alarming, Logging and Reporting

The aim of this paper is to present one of the ways to realize SCADA system and it solves the problem of incompatibility between industrial controllers, networks standards and protocols. The control system has been realized in laboratory conditions with industrial PLCs and industrial components. It consists of elevator platform (Fig. 1), distribution station and sorting station. It is suitable not only for education and training of students, engineers and researchers in the laboratory but also for control of real industrial mechatronic systems. The access to real mechatronic systems and remote Web laboratories via Internet is presented in [1, 3, 4].

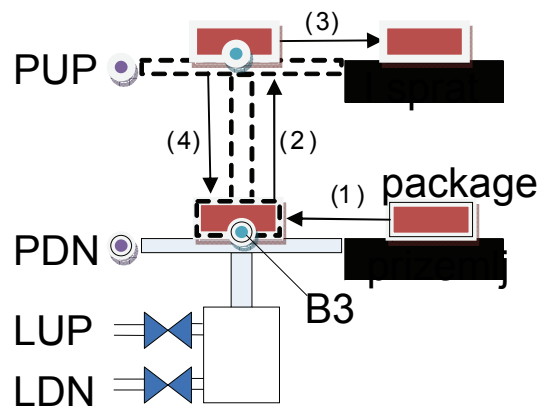

Fig. 1. Elevator platform

2. ARCHITECTURE AND STANDARDS

OPC is an open interface standard to provide data from PLC and communicate the data to any client application. The OPC is based on Microsoft OLE, COM and DCOM technologies and enables standardized data interchange between the industrial and the office sector. This technology provides standardized and fast exchange of data between OPC clients and PLC made by different manufacturers. OPC is used for data reading from process and for browsing of signals which are available in the OPC servers. OPC Client-Server structure is presented in Fig. 2.

Communication protocol enabling the communication with more applications at the same computer is Dynamic Data Exchange (DDE). This technology is supported by operating systems Microsoft Windows and OS/2. The basic function of DDE is to enable data sharing between different Windows applications. For example, the cell in Microsoft Excel can be connected to a variable in PLC so that when a physical value of the process is changed, it is automatically updated in Excel table. When this type of communication is in question, DDE client initiates the communication with other application and DDE server sends the message on connection. Upon connection being established, the client sends demands to the server.

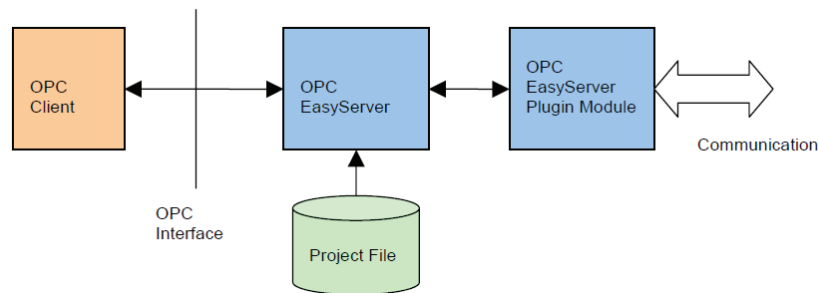

Fig. 2. OPC Client-Server structure

Initialization and establishment of communication between different computers in a network, as well as data exchange, are done by Network Dynamic Data Exchange (Net-DDE). It presents the intern Windows server available to all Windows platforms. This program enables LabVIEW application to make communication with Microsoft Excel so that the value of defined variable is memorized every second. LabVIEW uses ActiveX components which is a Microsoft technology based on COM (Component Object Model) and it enables to insert user code components into web pages. Festo EasyIP Protocol supports communication to a maximum of 255 Festo IPC/FEC devices using a standard TCP/IP protocol over Ethernet network. PLC station resource is identified with a user-defined name.

Plugin module automatically converts station resource name to capital letters and prevents space characters which are automatically underlined. TCP/IP address defines the IP address of the PLC station. This address is defined in the FST/MWT project. Each PLC station must have a unique IP address. IP address is identified with a string in the form 192.168.1.x. Plugin module supports only fixed IP addressing, i.e. each PLC must have a statically defined IP address. Scan time is a period between 2 consecutive EasyIP protocol

packages sent to the PLC. Scan time cannot be less than 10ms. Reasonable scan time is 100ms or higher. Scan time (in milliseconds) defines the frequency of communication. This is very important because it determines the update speed of variables within the OPC Client.

The lifting platform is activated by two-way pneumatic cylinder. Lifting and lowering are done by activation of electro-magnetic valve ElevatorUP (LUP=ON) and ElevatorDN (LDN=ON), respectively. Electro-magnetic valves are not active at the initial position. The elevator position is detected by two boundary micro switches PUP and PDN. Upper micro switch closes (PUP=ON) when the elevator reaches the first floor, while the lower micro switch (PDN=ON) closes when the elevator reaches the ground floor. The presence of package at the elevator platform is detected by optical sensor B3. The sensor becomes ON when the package is placed on the platform, and it becomes OFF when the package is removed. The initial position of the elevator platform is the ground floor. When the package is placed on the elevator platform (step 1) the elevator is lifted to the first floor (step 2) and it remains that position until the package is removed from the platform (step3), and then it is lowered to the ground floor (step 4). This is the algorithm of the platform operation:

1. The condition for activating the elevator upwards is set (F0.0) when the micro switch of lower position is active (PDN=ON) and when optical sensor detecting the object is active (B3=ON).
2. When the elevator platform reaches the first floor, the upper micro switch is activated (PUP=ON) and the condition F0.0 is reset.
3. The condition for activating the elevator downwards is set (F0.1) when the micro switch of upper position is active (PUP=ON) and when optical sensor detecting the object is not active (B3=OFF).
4. When the elevator platform reaches the ground floor, the lower micro switch is activated (PDN=ON) and the condition F0.1 is reset.

LabView is used in this paper to monitor and control mechatronic systems. ActiveX technology, which is applied to present virtual instruments, enables the measuring and monitoring of mechatronic systems through Web browser. This access to the systems is possible either by local area network (LAN) or by the Internet from any place all over the world. Virtual instruments are visible in Web browser but the program code is executed at Server. Program package LabVIEW possesses integrated Web Server which provides creation of wanted Web pages in which virtual instruments and control panels are presented. All these modules are installed into html on the Web page. Access from a remote computer to real systems is done by entering IP address of the server and the name of html page into Web browser. For instance, <http://192.168.0.201/sortirka.htm>, where 192.168.0.201 is the address of the computer in which the virtual monitor is, and *sortirka.htm* is the name of the Web page. The access to PLC as a Web Server is shown in the paper [4].

3. SYSTEM DESCRIPTION

The system consists of three independent mechatronic systems controlled by local PLCs connected into LAN by network cable. Distributing and sorting system is shown in Figure 3.



Fig. 3. Distributing and sorting station

Distributing station separates work pieces from the storing place. The fill level of the storing place is checked by a one-way light barrier. A double-acting cylinder pushes work pieces out individually. The charger module grips the separated piece with vacuum gripper. Driven by a rotary drive, the arm of charger moves the work piece to transfer point on conveyor of the sorting station. When diffuse sensor detects the work piece conveyor is started and stopper is activated. Sensors in the front of stopper detect the work piece characteristics (black, red or metal). The work pieces are stored in the appropriate slides via sorting gates, which are moved by means of short-stroke cylinders via diverting mechanism. A through-beam sensor monitors the filling level of the slides [6]. There are mechatronic systems connected into Local Area Network (LAN) with defined unique IP addresses (Fig. 4).

Each system is controlled by its own PLC. PLCs have the module installed for connecting into LAN network and for TCP/IP support. The first mechatronic system is controlled by PLC Festo FC-34 with unique IP address 192.168.1.81. The mechatronic system for piece distribution is controlled by Festo PLC FC-640 with IP address 192.168.1.200, while the system for piece sorting is controlled by Festo PLC FC-640 with unique IP address 192.168.1.201. The address of the computer on which EasyOPC server and LabView is installed is 192.168.1.80, and the network mask is 255.255.255.0.

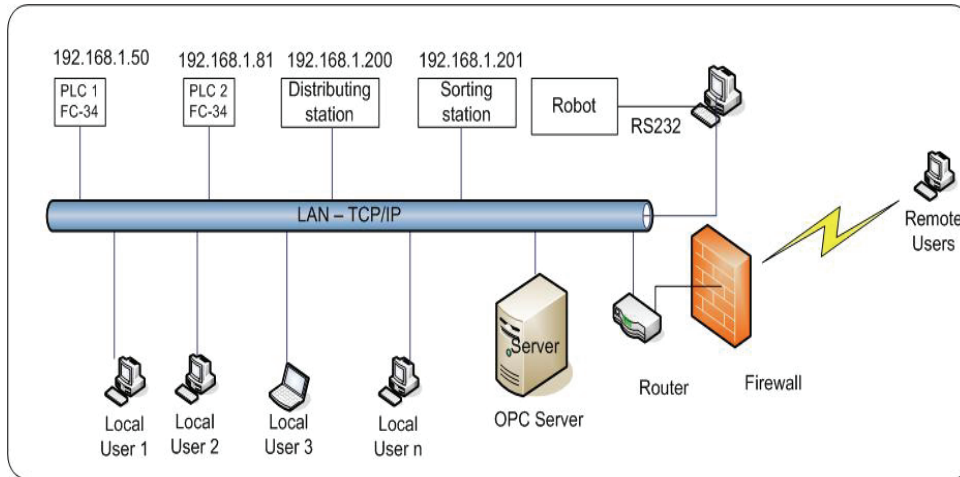

Fig. 4. LAN and OPC server

The first step for creating graphical environment is creation of new application in OPC server. Figure 5 shows the screen presenting mechatronic systems "Lift", "Distribute", and "Sort". Each system gets its own IP address of controlling PLC, as well as input and output tags.

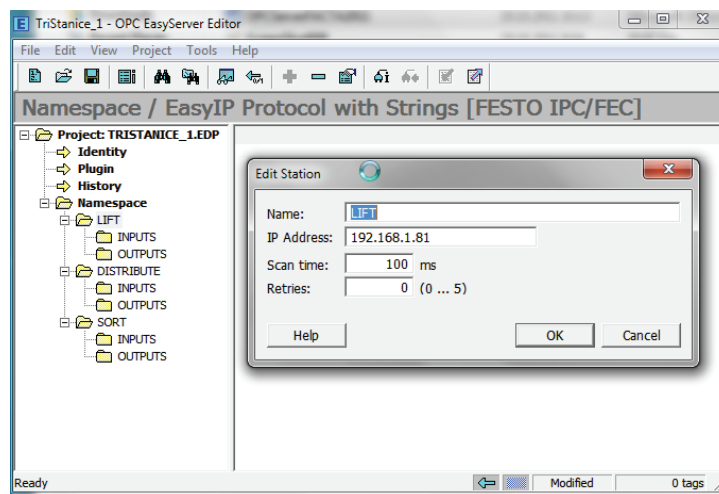

Fig. 5. Defining IP addresses of PLC

Each PLC must have defined inputs and outputs, and defined tags according to wanted input and output. Each tag gets defined appropriate variable type (word, bit, string) and the access manner, too. When the application is defined in OPC server, it is necessary to start OPC server and to load the application created. It is necessary to set the address of

OPC server, project name and wanted input/output for each measured and controlled PLC value. Figure 6 shows the screen for parameters configuration of VI Server in LabVIEW environment.

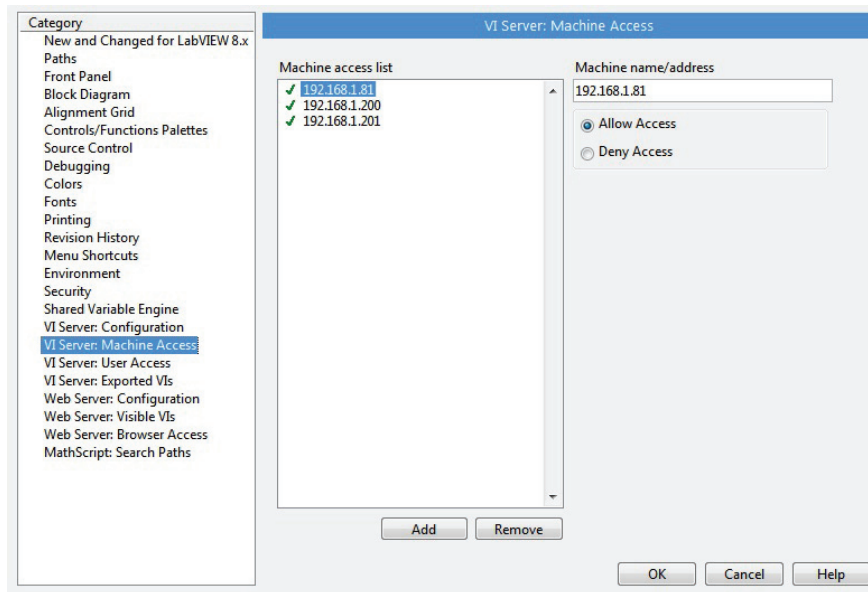

Fig. 6. LabView parameters configuration

4. REALIZATION OF GRAPHICAL INTERFACE IN LABVIEW

Software package LabVIEW is used to realize SCADA system. Initial screen of control interface is shown in Fig. 7. Graphical buttons for each system are realized along with the indicators for: selection of mode of operation, switch on, switch off, unset, error signal, setting and monitoring the pressure within the system. New graphical screens are defined for each mechatronic system in order to achieve total system control. Mechatronic systems for distribution and sorting can select mode of operation, either manual or automatic mode (Man/Auto).

Manual mode of operation is usually selected for testing and diagnosing mechatronic systems, when it is possible to activate each actuator individually where the changes of the sensor states are monitored. All changes at the outputs are updated in real time and shown at the operating panel of LabVIEW. It is necessary to monitor operating algorithm of mechatronic system in order to make successful testing and diagnosing. Figure 8 shows the operating algorithm of distributing station. Monitoring the operating algorithm and system parameters at the control display makes it easy to detect and eliminate the failure of mechatronic system.

The system has been developed at Engineering School Trstenik in order to realize laboratory exercises. The graphical application realized in LabVIEW is used for control, monitoring and remote elimination of system errors. Apart from the major function, the application enables creation of tabular and graphical displays of the most frequent failures in defined time interval. The sensors whose states are monitored are:

- Sensor of the system pressure
- Optical sensor of storing place
- Vacuum switch
- Sensors of positions at pneumatic cylinders
- Photo sensors for operation synchronization
- Colour sensor at sorting station
- Inductive sensor at sorting station
- Reflex photo sensor – sorting storing place is full

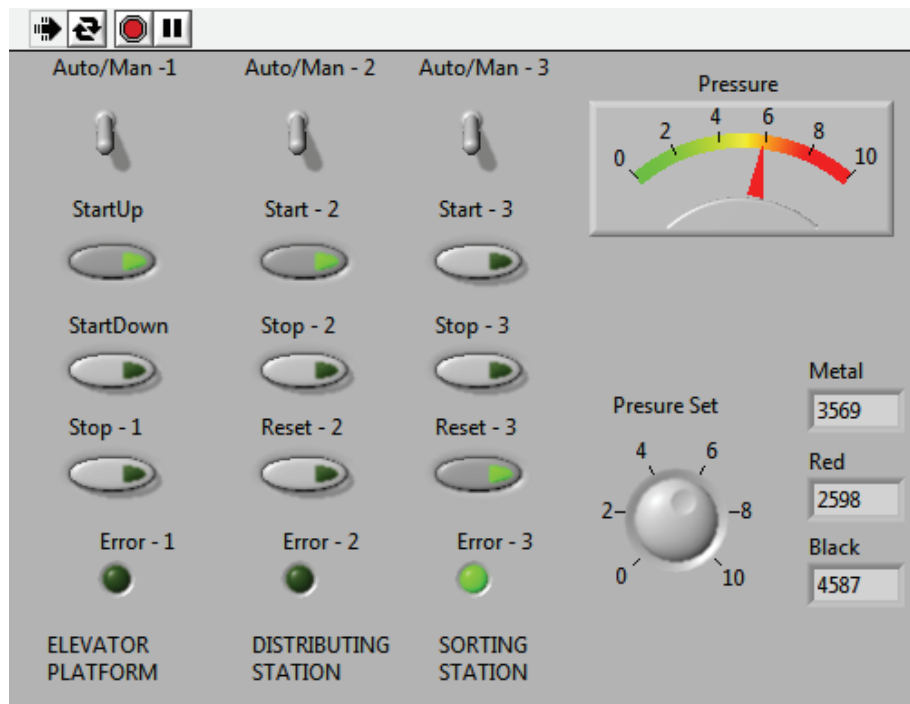

Fig. 7. Graphical interface of control panel

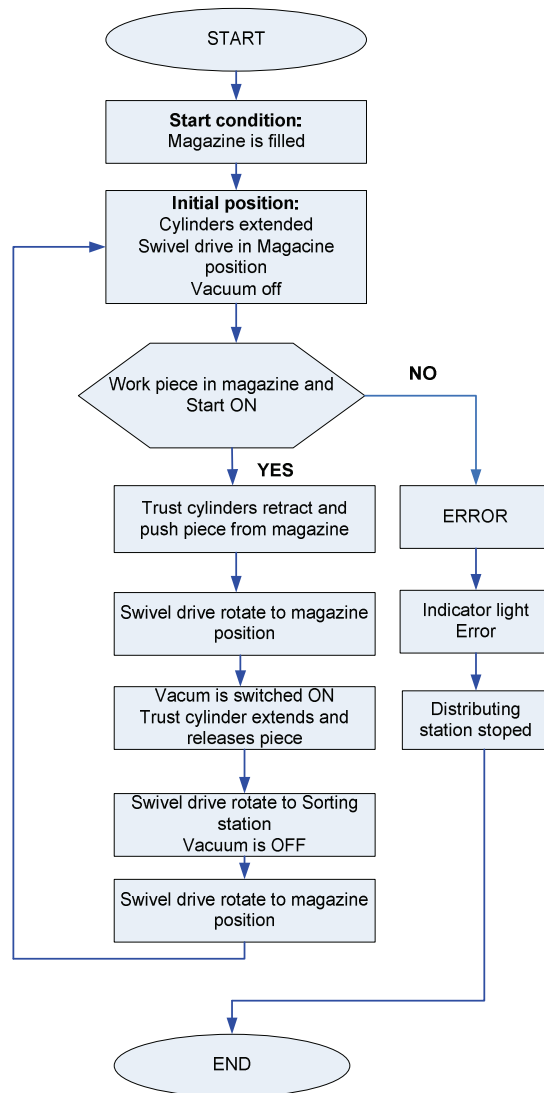

Fig. 8. Operating algorithm of distributing station

5. CONCLUSION

This paper presents the system for visual monitoring and control of didactic systems controlled by PLC and connected into local area network (LAN). OPC Easy Server is used to access PLC made by different manufacturers whereas software package LabView is used to create graphical control environment. Fusion of these two software packages forms a powerful SCADA system which enables access to users worldwide by the Internet. This system provides monitoring of all analog and digital signals which are

significant to users, as well as controlling mechatronic systems in real time. The system can be applied not only for classical education and electronic distance learning but also for monitoring and controlling real industrial automatic systems in real time. IP video cameras of high resolution should be installed in order to reach more comfortable operation and insight into behavior of real mechatronic systems. A special attention should be paid to time delay through LAN, delay due to the Internet network, definition of access right and protection from unauthorized access.

REFERENCES

1. V.M. Cvjetković, M. Matijević, V. Ranković, M. Stefanović, "Internet-mediated process control laboratory", Facta Universitatis, Series: Automatic Control and Robotics, vol. 7, no. 1, pp.35-44, 2008.
2. M. Demetgul, I.N. Tansel, S. Taskin, "Fault diagnosis of pneumatic systems with artificial neural network algorithms," Journal of Expert Systems with Applications, vol. 36, pp. 10512-10519, 2009.
3. S. Aleksandrov, Z. Jovanović, S. Čajetinac, L. Stoimenov, "Access to PLC in real-time software package Team Viewer", Proceedings of the X Triennial International SAUM Conference on Systems, Automatic Control and Measurements Niš, Serbia, November 10th-12th, 2010, pp. 145-148.
4. S. Aleksandrov, S. Čajetinac, Z. Jovanović, "Internet access to PLC with integrated web server", Proceedings of the 11th International Conference Research and Development in Mechanical Industry, RaDMI 2011, September, 15.-18., 2011, Sokobanja, Serbia, pp.425-430.
5. E. Yazan, M. Al Rawashdeh, "Embedded web-server", Automation Lab Manual, University of Jordan, Faculty of Engineering and Technology, 2009-2010.
6. S. Aleksandrov, S. Čajetinac, D. Šešlija, "Didactic system Festo MPS – sorting station and its application in education in the field of mechatronics", Proceedings of the 10th International Conference Research and Development in Mechanical Industry, RaDMI 2010, , Donji Milanovac, Serbia, 16 - 19. September 2010, pp. 549-553.
7. Festo OPC EasyServer, User Manual, 2004.
8. LabVIEW Measurements Manual, National Instruments, 2003.
9. H. Laget, F. Valle, F. Tadeo, "Web based remote control of an electro-pneumatic process", Dpto.Ingenieria de sistemas y Automatica, 47005 Valladolid, Spain.
10. Eslami, A. Wiliams, L. Lapat, K. Krauss, "A remote control project to enhance undergraduate students", Proceedings of the Interest and Knowledge in Industrial Automation.
11. M. Chaabene, K. Mkaouar, M. Ouali, "A web-based interactive real laboratory for process engineering education", Journal of Computer Science, vol. 3(7), pp. 540-545, 2007.

FORMIRANJE SCADA SISTEMA ZASNOVANOG NA OPC SERVER I LABVIEW ZA UPRAVLJANJE MEHATRONSKIM SISTEMIMA

Slobodan Aleksandrov, Zoran Jovanović, Saša Nikolić, Stanimir Čajetinac

U ovom radu prezentovan je SCADA sistem za kontrolu i nadzor mehatronskih sistema, koji su upravljani programibilnim logičkim kontrolerima (PLC) i povezani u lokalnu računarsku mrežu (LAN). Za pristup PLC-u koristi se aplikacija OPC EasyServer, za kreiranje grafičkog nadzorno upravljačkog okruženja softverski paket LabView i za programiranje PLC-a Festov softver FST 4.10. Svaki od PLC-a ima svoju jedinstvenu IP adresu, a svaki od ulaznih i izlaznih signala PLC-a, jedinstvenu lokalnu adresu. Realizovani sistem omogućava grafički interfejs za upravljanje, nadzor i kontrolu željenih fizičkih veličina procesa i parametara sistema. Velika prednost predstavljenog rešenja je mogućnost upravljanje sistemima realizovanih sa različitim tipovima PLC-a, PLC-a različitih proizvođača, upravljanje u lokalnoj računarskoj mreži, kao i upravljanje i nadzor mehatronskim sistemima preko Interneta, bez obzira na geografsku lokaciju operatera i procesa.

Ključne reči: Upravljanje, mehatronski sistem, PLC, OPC server, TCP/IP, Internet